

USER MANUAL

CT1000 v2

CT1000 v2 is a touch keypad that can be installed and used for many different purposes, e.g. to open a door, turn on the light, or call for an elevator - just a few among many other options.

Art.no. 460100 - CT1000v2 Black
Art.no. 460106 - CT1000v2 White.

www.conlan.eu

CT1000 v2

CONLAN

A **SALTO** GROUP COMPANY



CONTENT

1. INSTALLATION	Page 3
2. ACCESS	Page 3
2.1. Using the device	Page 3
3. FIXED USER PIN CODES MANAGEMENT	Page 4
3.1 Add user PIN codes	Page 5
3.2 Delete user codes	Page 5
4. CONFIGURATION	Page 6
4.1 Software Factory Reset	Page 6
4.2 Delete All User PIN Codes	Page 7
4.3 Change User Configuration Code	Page 7
4.4 Change Service Configuration Code	Page 8
4.5 Light indications	Page 8
4.5.1 Idle State Indication	Page 9
4.5.2 Output2 Active State Indication	Page 9
4.5.3 Wrong PIN Inserted Indication	Page 9
4.5.4 Back Lights Configuration	Page 10
4.6 Outputs Configuration	Page 11
4.7 Feedback	Page 13
4.8 Special Functions	Page 15
4.9 Splitter and Bell Function	Page 16
4.10 Custom User Output	Page 18
5. HARDWARE FACTORY RESET	Page 19
6. REX INPUT	Page 20
7. TECHNICAL SPECIFICATIONS	Page 20

1. INSTALLATION

To learn how to install the keypad, please refer to the installation guide.

2. ACCESS

The keypad is a standalone device that allows access to open a lock by entering a custom user PIN code.

2.1. Using the device

The CT1000 v2 can store up to 200 fixed PIN codes that range from 1 to 8 digits long. Each user is allocated their own PIN code to operate the lock, which also enables sharing one lock between different users.

The default fixed PIN code '1234' is pre-configured at position 1 during fabrication and can be used to test the device.

To manage the fixed user PIN codes, please refer to section 3, 'Fixed User PIN Codes Management', on page 4.

Idle State

When the device is idle, the yellow light (factory default) is always ON, and the keypad is waiting for user interaction.

The back-lights are OFF by default but turn on when a key is touched.

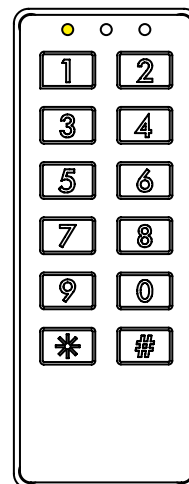

Opening and Closing

Example:

1

2

3

4

#

When a valid user PIN code is inserted, a confirmation beep will sound, and the green LED will light as long as Output2 is activated (default 5 seconds).

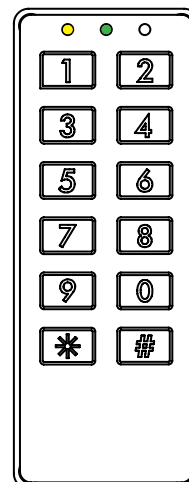

Wrong Code

Example:



When a wrong code is entered, a rejection beep will sound, and the red LED will blink three times.

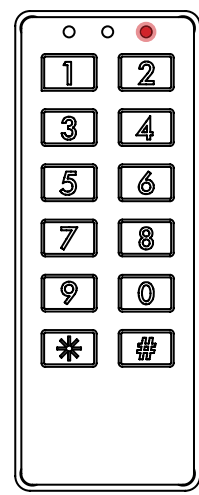

If four successive wrong attempts are made, the keypad will lock out for 60 seconds.

3. FIXED USER PIN CODES MANAGEMENT

Each user code is stored in a specific address of internal memory (from 1 to 200). We recommend keeping a record of the position number and user names for future management.

To add or delete user codes, you need to access the User Configuration Menu by entering the User Configuration Code (factory default is 4711) followed by '#'.

User Configuration Menu

Enter:



The green LED will blink, indicating that the keypad is ready to add or delete fixed user PIN codes.

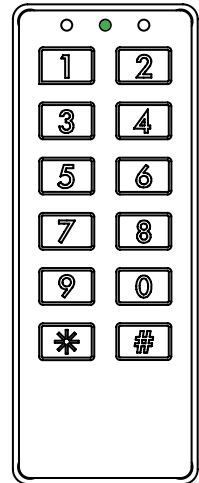

Example of user tracking:

	Position	User	PIN
	1	Carlos	148954
	17	Torbjörn	94830132
Example:	23	Juan	1111

The next sections uses Juan as example to add and delete fixed PIN codes on the device.

3.1 Add user PIN codes

Insert:

The yellow LED will blink rapidly. Then insert a user position between 1 and 200 to place the new PIN code.

Example:

When a valid position is entered, the yellow LED will blink slowly while the green LED will blink rapidly until a new user PIN code is inserted. It's important to note that the new user PIN must consist of a numeric sequence that ranges from 1 to 8 digits.

Example:

It's important to note that all positions can be overwritten, which means that you should keep a record of all configured PIN codes and their corresponding positions. This will help you avoid accidentally deleting or modifying any existing PIN codes.

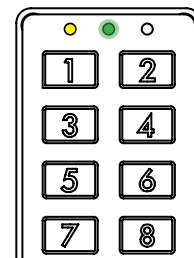
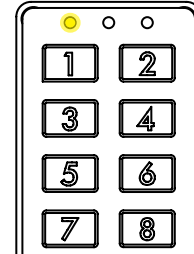

3.2 Delete user codes

To delete one or more fixed PIN codes, you don't need to know the specific code, but you must know its position.

Deleting a specific PIN code

Insert:

The red LED will blink rapidly. Then insert the position of the PIN code that you want to delete and press '#' to confirm the deletion. (a number between 1 and 200).

Example:

If a valid position is entered, a confirmation beep will sound, then the keypad go back to User Configuration Menu and is ready to perform another user PIN handling action.

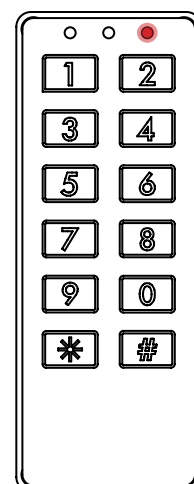

4. CONFIGURATION

To configure the CT1000 v2, you need to access the Service Configuration Menu with the Service Configuration Code (12347890 as factory default). This code is used to authenticate and access the menu.

You can access this menu within the first 5 minutes after the device has been powered up, after which it becomes inaccessible.

Within the first 5 minutes after the device has been powered up

Insert:



The green LED will blink, indicating that the keypad is ready to be configured.

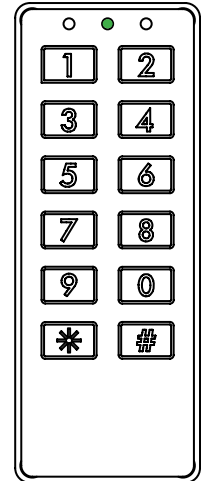

Once in Service Configuration Menu, the following actions can be performed:

4.1 Software Factory Reset

If you need to reset the device to its factory default settings, please follow these steps:

Insert:



A confirmation beep will sound and all indication LEDs will light up for a few seconds. Then, the device will automatically restart and return to the idle state.

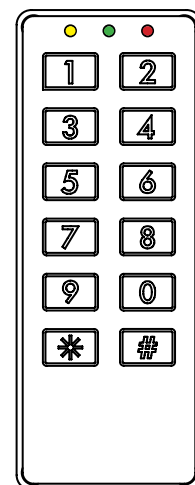

4.2 Delete All User PIN Codes

To clear all stored user PIN codes from the device's memory, please follow these steps:

Insert:

2

5

0

0

#

A confirmation beep will sound to indicate that all the stored PIN codes have been deleted.

The keypad will return to the Service Configuration Menu and will be ready to perform another action.

4.3 Change User Configuration Code

Insert:

1

#

The red LED will blink slowly. Insert a new User Configuration Code between 4 to 8 digits

Example:

4

3

2

1

#

The User Configuration Code has been changed. The keypad will go back to Service Configuration Menu and is ready to perform another Service Configuration action.

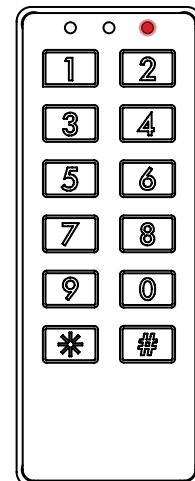

4.4 Change Service Configuration Code

Insert:

The green LED will blink slowly. The keypad is ready to receive a new Service Configuration Code. Insert a code that is between 4 to 8 digits.

Example:

The green LED will blink slowly while the yellow LED will blink rapidly until the new Service Configuration Code is inserted again to confirm the action. Insert the same code again.

Example:

The Service Configuration Code has been changed. The keypad go back to Service Configuration Menu and is ready to perform another Service Configuration action.

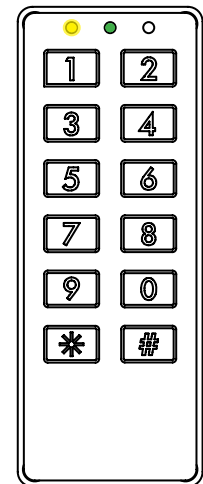
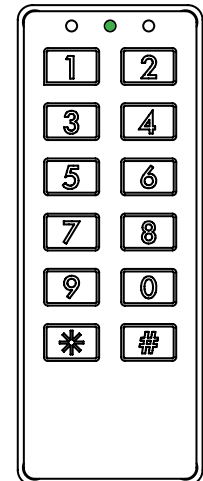

4.5 Light indications

The light indications for different device states can be customized as follows:

To access the LED configuration menu:

Insert:

The green and red LEDs will blink slowly.

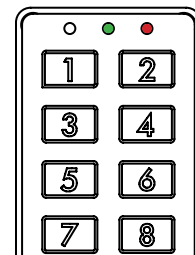

4.5.1 Idle State Indication

Is the device normal state, it remains idle until a user action is performed.

Insert:

The device shows the current Idle State indication. The yellow LED ON as default.

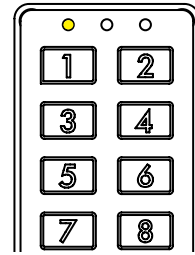

4.5.2 Output2 Active State Indication

This will show when OUTPTU2 is active (regardless of whether it's floating or GND as output signal) by a right user PIN code inserted or a REX input triggered for example.

Insert:

The device shows the current OUTPTU2 Active State indication. The yellow and green LED's ON as default.

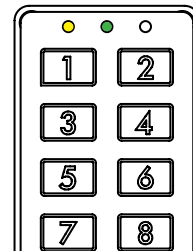

4.5.3 Wrong PIN Inserted Indication

Insert:

The device shows the current Wrong PIN Inserted indication. The red LED ON as default.

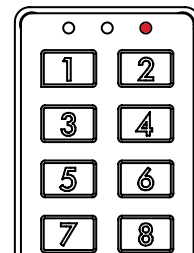

To customize these three configurations, the desired LED can be turned ON or OFF by pushing 1 to toggle the yellow LED, 2 to toggle the green LED, and 3 to toggle the red LED. Once the indication is as desired, push # to save it.

Values to toggle the LED's:

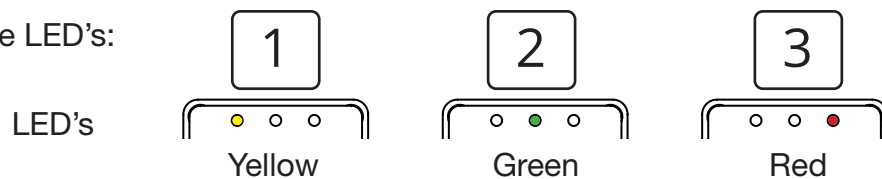

Insert: To save the changes. After each customization, the device returns to the Light Indications menu, and another configuration can be performed.

4.5.4 Back Lights Configuration

Insert: 4 #

The device turns OFF all indication LED's and shows the current Back Lights State.

As default the Back Lights are turned ON for 5 seconds when a key is touched, after what the lights turns OFF again. This state is indicated by a slow blink of the Back Lights.

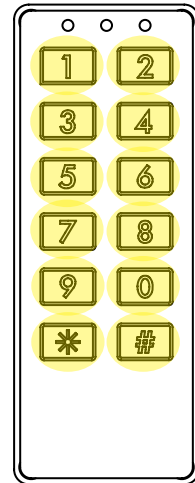

Insert: 4 To toggle the back lights state.

Three states are allowed:

- Always ON
- Always OFF
- Turn ON for 5 seconds when a key is touched (indicated by a slow blink of the Back Lights).

Insert: # To save the changes. After each customization, the device returns to the Light Indications menu, and another configuration can be performed.

4.6 Outputs Configuration

Insert: For Output 1

The yellow LED will blink slowly for Output1.

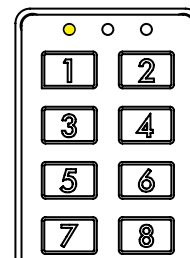

OR

Insert: For Output 2

The yellow and red LED's will blink slowly for Output2.

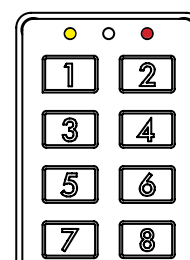

The device's outputs can be configured with the following parameters:

- 1. Normal Mode:** In this mode, the output is floating in idle state and grounded when active.
- 2. Toggle Mode:** In this mode, the output toggles between floating and grounded states each time it's activated. The output state in this mode is maintained even if the device is power-cycled, to avoid wrong initial states after a power cut.
- 3. Inverted Mode:** In this mode, the idle state is grounded and the active state is floating.

When the output is configured in Normal or Inverted mode, an activation time must be set, which can range from 1 second to 12 hours.

Insert: For Toggle Mode

The Output Configuration has been changed. The keypad will go back to Service Configuration Menu and is ready to perform another Service Configuration action.

Insert: For Normal Mode

Or

Insert: For Inverted Mode

An activation time must be set.

The yellow LED blinks to indicate time configuration. Insert time in hours (between 0 to 12) to activate the correspondent output.

Insert: To confirm.

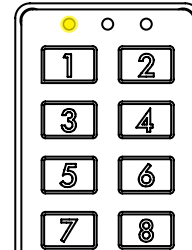

The yellow LED will blink slowly and the green LED will blink fast, indicating that the device is waiting for a time in minutes , insert a time between 0 and 60.

Insert: To confirm.

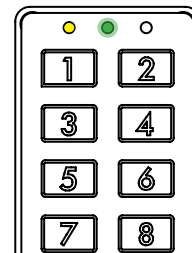

The yellow and green LEDs will blink slowly and the red LED will blink fast. Insert a time in seconds between 1 and 60.

Insert: To save the changes. The device returns to the Service Configuration menu, and another configuration can be performed.

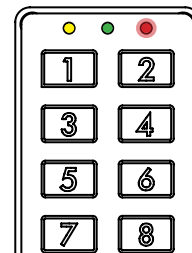

4.7 Feedback

This function allows changing the exBuzzer input behavior to use it as a Feedback input. When the configured input is Active, it will switch to an Inactive state once the Feedback input is triggered (grounded).

This feature is particularly useful when using a sensor to detect if a door is open or locked. After the user enters a valid PIN, the output is activated to grant access and the door can be opened. Once the door is closed, the feedback input detects the door state through the sensor and disables the output immediately to deny access until another valid PIN is entered, instead of waiting for the output timeout to expire.

To use the Feedback input, only one Output can be configured at a time, and the Feedback activation edge must be set. This can be done in two ways:

- **High to Low:** the input is in idle state when it's Floating (not connected) and triggers the Feedback effect when the state changes from Floating to GND.
- **Low to High:** the input is in idle state when it's grounded (GND) and triggers the Feedback effect when the state changes from GND to Floating.

Insert: To configure the Feedback function

The green and yellow LED's will blink slowly .
Now an Output can be selected to work with the Feedback input.

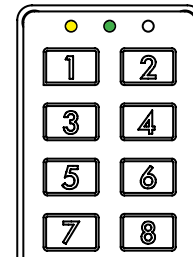

Insert: To disable the Feedback function. exBuzz Input returns to its default state, which activates the Buzzer when grounded

Insert: For Output 1
OR

Insert: For Output 2

The green LED will blink rapidly to indicate that a trigger flank needs to be configured.

Insert: For High to Low Flank
OR
Insert: For Low to High Flank

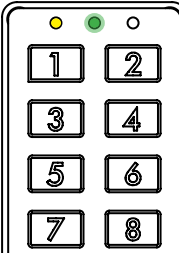

Insert: To save the changes. The device returns to the Service Configuration menu, and another configuration can be performed.

4.8 Special Functions

You can enable or disable four special functions:

- 1. Mute:** To turn ON/OFF the device's sound.
- 2. Service Code Timeout:** By default ON, it means you can only use the Service Configuration Code within the first 5 minutes after powering up. When this option is turned OFF, the Service Configuration Code will work anytime.
- 3. Hold Function:** This is a special type of hold function that changes the behavior of the ex-Buzzer input to a kind of feedback control. To grant access to a user, the exBuzzer input needs to 'confirm' the action by be grounded every time a valid code is entered. If no confirmation is received after 1 minute, the device returns to idle state.
- 4. Rolling Code:** You no longer need to press '#' to confirm a PIN entry. The PIN code is evaluated immediately after 4 digits are entered. This mode only works with 4-digit user PIN codes. To enter the Service Configuration Code (8 digits), press '#' 4 times to disable the 4-digit restriction for 10 seconds.

Insert:   To configure the Special Functions

The green, yellow and red LED's will blink slowly.

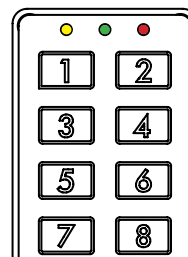

You can enable or disable the four special functions by pressing the corresponding key. The LED indicators will show whether a function is enabled (Green blinks) or disabled (Red blinks):

Insert:  For Mute

Insert:  For Service Code Timeout

Insert:  For Hold Function

Insert:  For Rolling Code

Insert:  To save the changes. The device returns to the Special Functions menu, and another configuration can be performed.

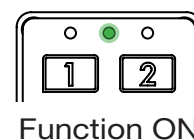

Function ON

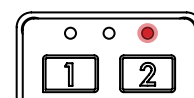

Function OFF

4.9 Splitter and Bell Function

The device, as default, is configured to activate Output2 (yellow wire) every time a valid code is inserted. Besides, the Output1 (white wire) is activated every time the Bell Key  is pushed.

To change this default behavior:

Enter: 7 #

The yellow and green LED's will light solid until a **Splitter** value position is inserted.

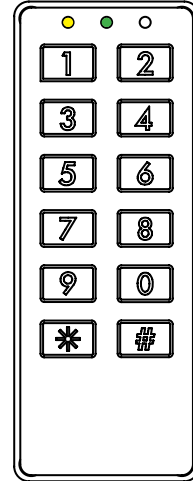

This function uses an User PIN Output Assignment Array to assign a defined Output to a group of user PIN's. As default, this array looks like follows:

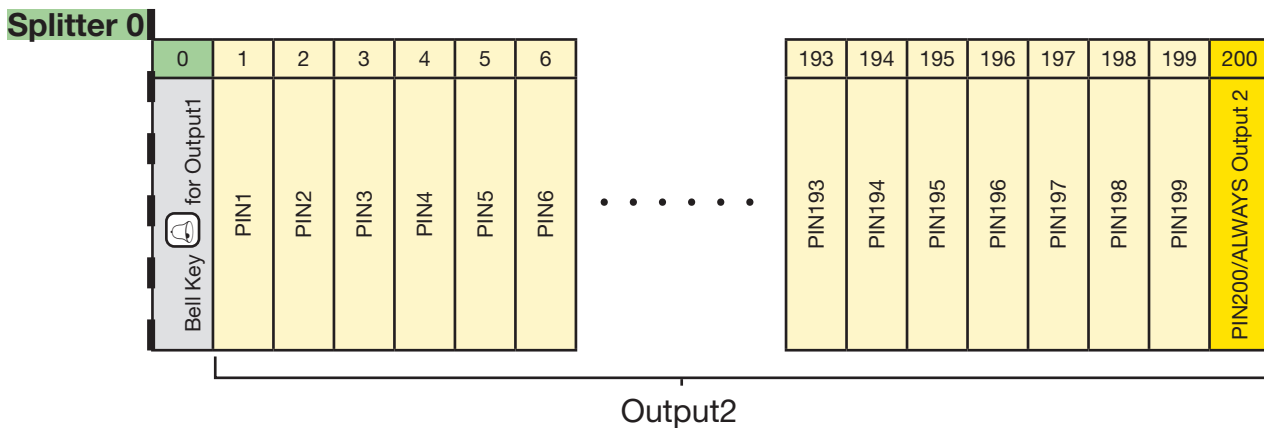

Note that if the configured value is **0** (default configuration), all User PIN codes activates Output2 and only the Bell Key , activates Output1.

If the configured value **is not 0**, the Bell Key  is disabled and we assume this value as a **Splitter** position for the User PIN Output Assignment Array, where all positions behind the **Splitter** activates Output1, and all positions in front of the **Splitter** and inclusive the **Splitter** itself activates Output2.

In the next example, we use 5 as **Splitter**. It configures all user PIN codes from 1 to 4 to activate Output1 and all user PIN codes from 5 to 200 to activate Output2. The Bell Key , doesn't activate the Output1 anymore, it is used to clear the PIN code buffer in stead.

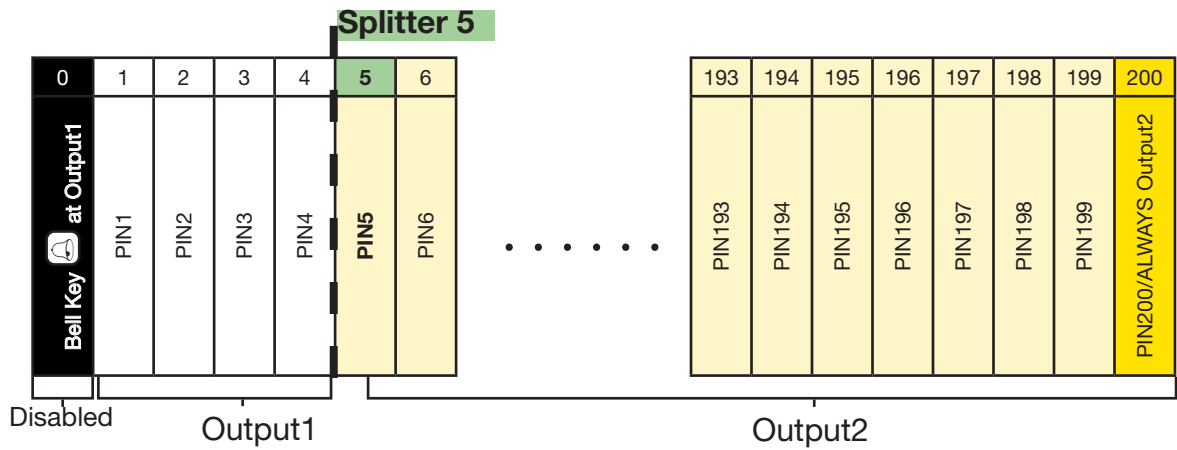

Enter:

The keypad go back to User Configuration Menu and is ready to perform another action. All user PIN codes from 1 to 4 activates Output1 and all user PIN codes from 6 to 200 activates Output2

1 and 200 are considered “special values”. If the Splitter value is 1, all user PIN’s activates Output2, whereas if the Splitters value is 200, all user PIN’s activates Output1. In both cases, the Bell Key  function is used only to clear the PIN code buffer and doesn’t activate Output1.

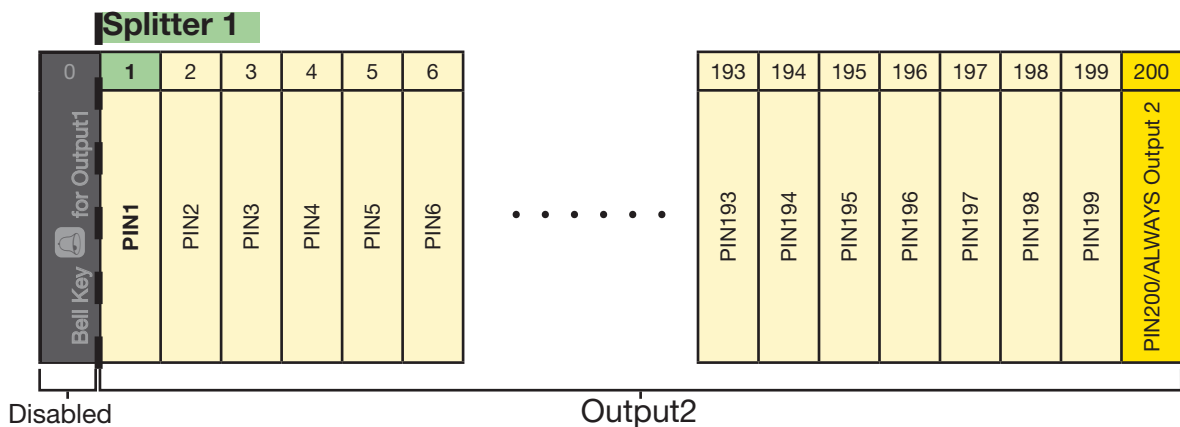

Enter:

The keypad go back to User Configuration Menu and is ready to perform another action. All user PIN codes from 1 to 200 activates Output2

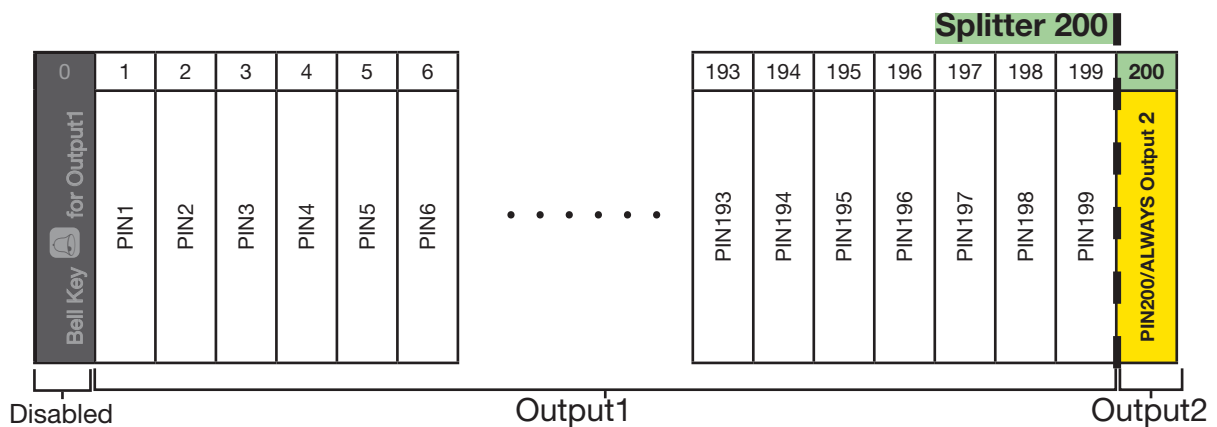

Enter:

The keypad go back to User Configuration Menu and is ready to perform another action. All user PIN codes from 1 to 199 activates Output1, PIN 200 activates Output 2

4.10 Custom User Output

It's possible to customize the output and its behavior for specific users. In this menu, you can assign a custom output to a specific user, that can be different from the default output signed by the Splitter. This customized output can be configured as Normal (with a default Output timeout - refer to section 4.4 "Outputs Configuration" to choose a timeout) or Toggle, but only for the selected user.

To customize the output and behavior for a specific user, follow these steps:

Enter the menu to customizing User Outputs:

Insert:

The red and green LED's will blink slowly, and the yellow LED will blink rapidly.

Choose the user for whom you want to customize the output, insert a user position between 1 and 200, and make sure that the position contains already a PIN code.

Example:

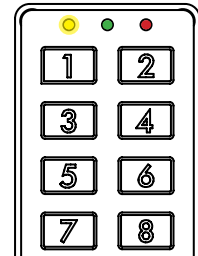

The yellow and red LED's will blink slowly, and the green LED will blink rapidly.

Assign a custom output to the user by entering 1 for Output1 or 2 for Output2.

Example:

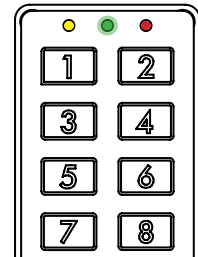

The yellow and green LED's will blink slowly, and the red LED will blink rapidly. Choose whether the customized output should be configured as Normal by entering 1 or Toggle by entering 2, for the selected user.

Insert: To save the changes. The device returns to the Service Configuration menu, and another configuration can be performed.

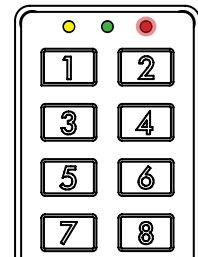

5. HARDWARE FACTORY RESET

If you need to reset the device to its factory default settings, please follow these steps:

1. Disconnect the Power Supply, ensure the device is not powered.

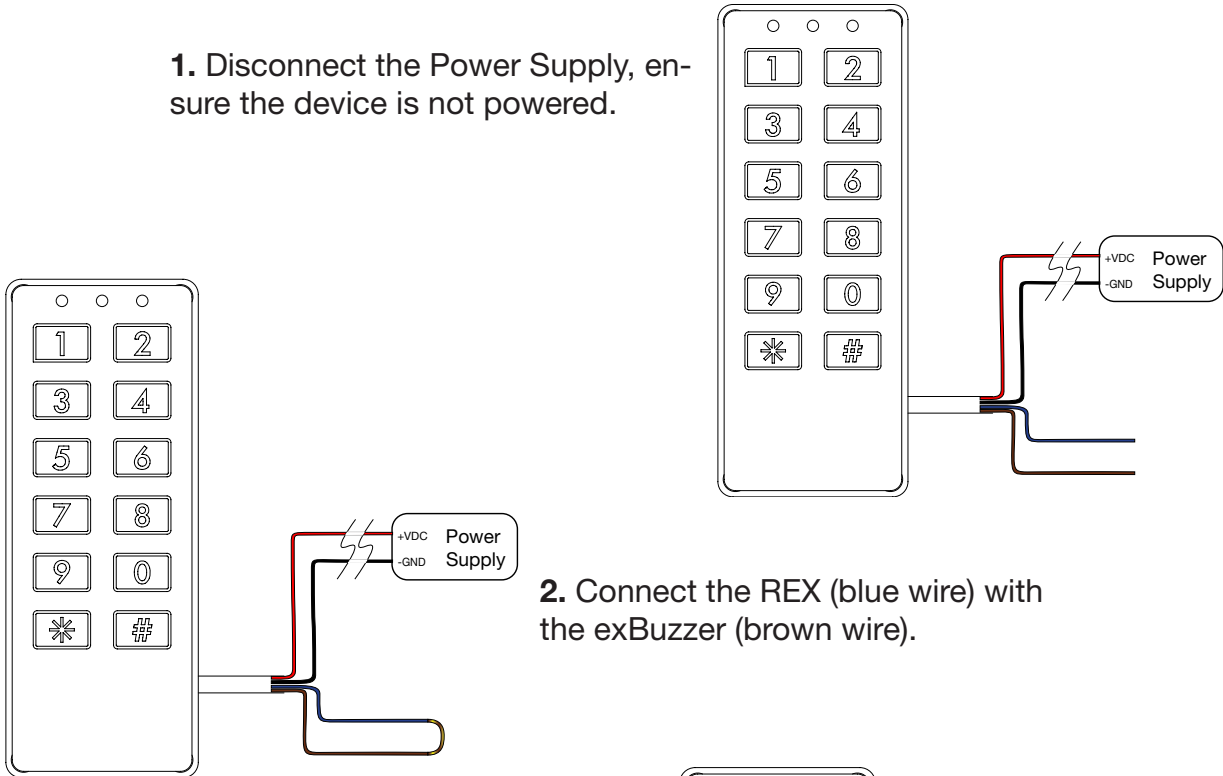

2. Connect the REX (blue wire) with the exBuzzer (brown wire).

3. Connect the Power supply again and power the device. All three LED's turns ON and the buzzer makes a confirmation beep.

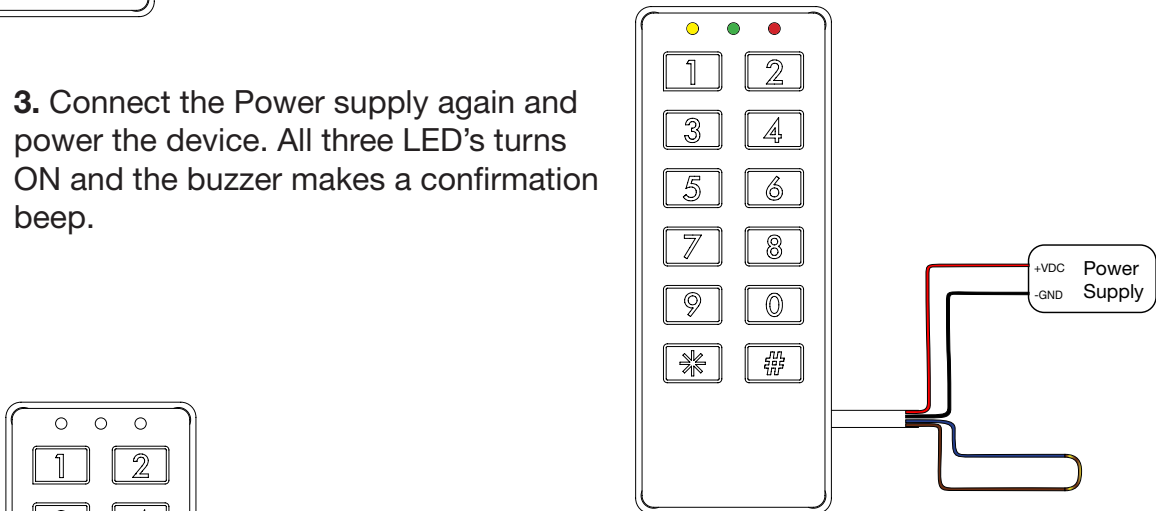

4. Disconnect the Power Supply, ensure the device is not powered.

5. Disconnect the REX (blue wire) and the ex-Buzzer (brown wire). The device is now ready to be used again and all configurations are set as factory default.

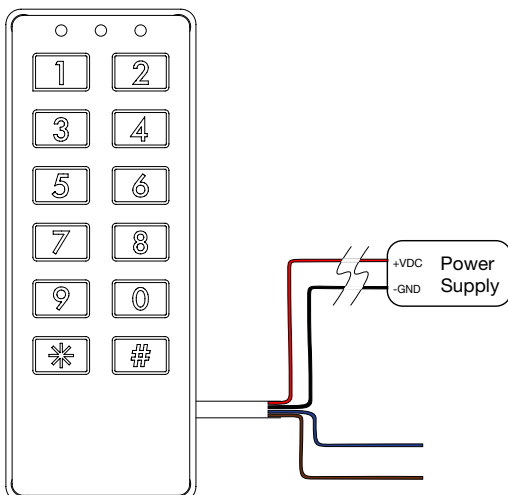

6. REX INPUT

REX means **R**equest to **EX**it. In the CT1000 v2, the REX input will produce Output2 activation as a consequence of someone attempting to egress through a door.

REX is used for three primary reasons:

First, access control systems may control doors which are also being monitored for security management, to indicate exception conditions on remote monitoring equipment.

Second, access control systems may utilize electrically actuated bolts, electromagnetic lock, shear locks, or a combination of locking devices which do not provide an integral means of manually unlocking the door to allow free egress. For the majority of applications, building and Fire Codes will mandate that any door along the path of egress (and most internal doors) allow free egress at all times.

There are exceptions, but these exceptions generally apply to institutional applications (such as detention facilities or psychiatric wards), government high security and special locking arrangements (such as delayed egress). Suitability of an opening for anything other than Free Egress will always be ultimately determined by the AHJ (Authority Having Jurisdiction). There may be times when more than one AHJ may be involved, in which case conflicts between them have been known to occur, as each may interpret the code differently. The bottom line is that for those situations where the electric locking device does not have any integral means of unlocking it for free egress, the REX input becomes a critical elements to the system behavior.

7. TECHNICAL SPECIFICATIONS

Device measures:	50.3 mm x 130.3 mm x 8 mm
Power source:	9 to 24 VDC (12VDC Recommended)
Power consumption on Idle:	3.96 mA at 12VDC
Inputs:	exGreen, exRed, exBuzzer and REX [Active LOW (-/GND)]
Outputs:	Output1 and Output2, Open Collector [Active LOW (-/GND)]
Protection rate:	IP67
Environmental conditions:	Temperature: -35°C to +66°C
Color:	White or Black.